

F-Theta JENar® APTALine® Lens

High Power Lens – JENar® APTALine® 255-1030...1080-160-AL

Parameters	JENar® APTALine® 255-1030...1080-160-AL Fused silica lens
Focal length:	255 mm
Wavelength:	1030...1080 nm
Scan field (X x Y); Ø:	(114 mm x 114 mm); 160 mm
Diagonal scan angle:	± 18°
X/Y mirror angle:	± 6.4°
Back working distance:	303.3 mm
Flange focus distance:	387.8 mm
Input beam Ø 1/e ² :	20 mm
Focus size Ø 1/e ² :	25 µm
a1 a2:	25 mm 48.46 mm
Telecentricity (only F-Theta with scanner):	7.2° 7.4°
Absorption:	fused silica: < 15 ppm/cm coating: < 25 ppm
Group delay dispersion (GDD)*:	904 fs ²
LIDT coating pulsed; CW*:	2.5 J/cm ² * (τ/[ns]) ^ 0.30; 2.5 MW/cm ²
LIDT system pulsed; CW*:	2.5 J/cm ² * (τ/[ns]) ^ 0.30; 2.5 MW/cm ²
Weight:	1.2 kg
Order Number:	689622

Spot properties

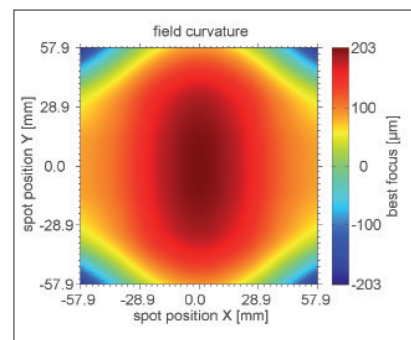
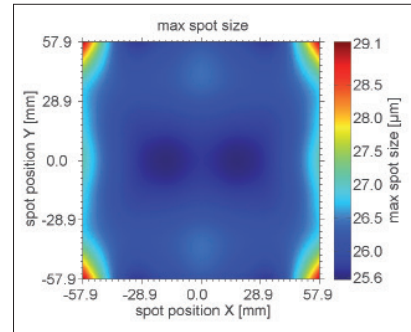

Specifications

JENar® APTALine® 255-1030...1080-160-AL

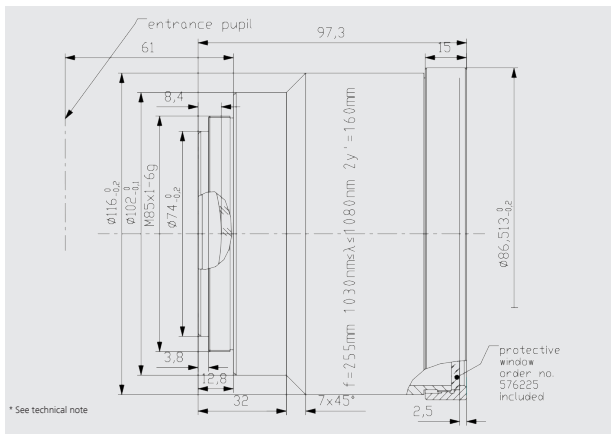

Definition of geometrical parameters

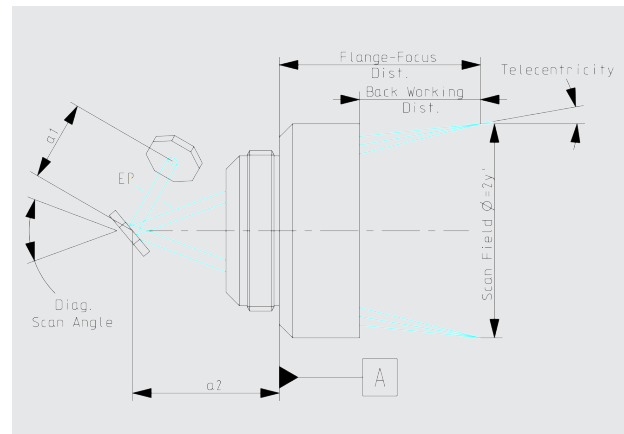

JENar® registered in: EU, CN, JP, SG, US
 F-Theta registered in: EU, CN, KR, JP, SG, IN, HK, TW
 APTALine® registered in: DE, EU, JP, KR, US, CN

The data given are nominal values for the specified application parameters. Jenoptik provides Zemax® BlackBox files for simulating application results for customized parameters (e.g. wavelength, scanner geometry, beam diameter, ...).
 Back working distance, Flange focus distance, and focal length vary by ± 1.5 % due to manufacturing variances.

It is our policy to constantly improve the design and specifications. Accordingly, the details represented herein cannot be regarded as final and binding.